

ASSEMBLED VIEW

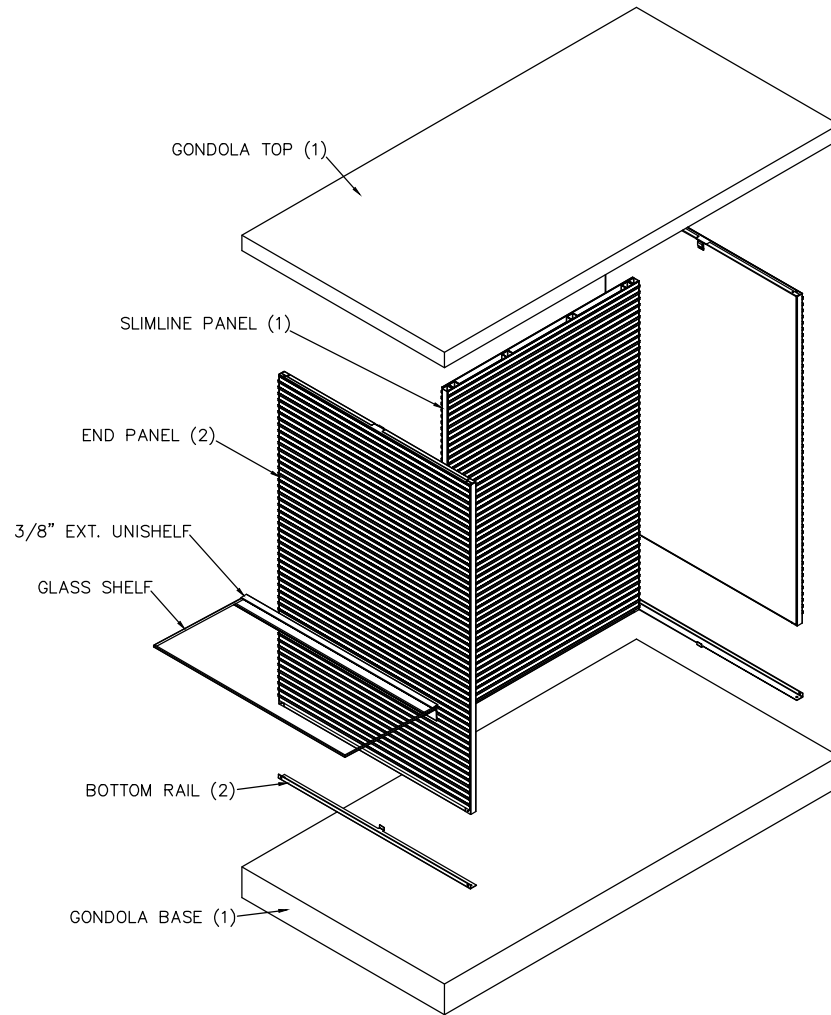

EXPLODED ASSEMBLY VIEW

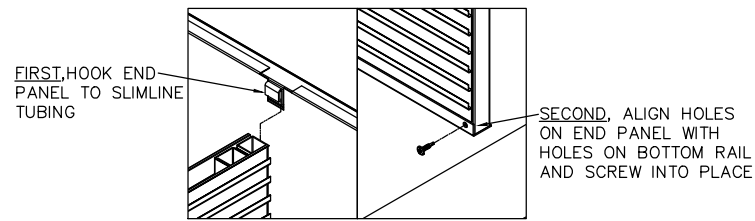

Detail 2

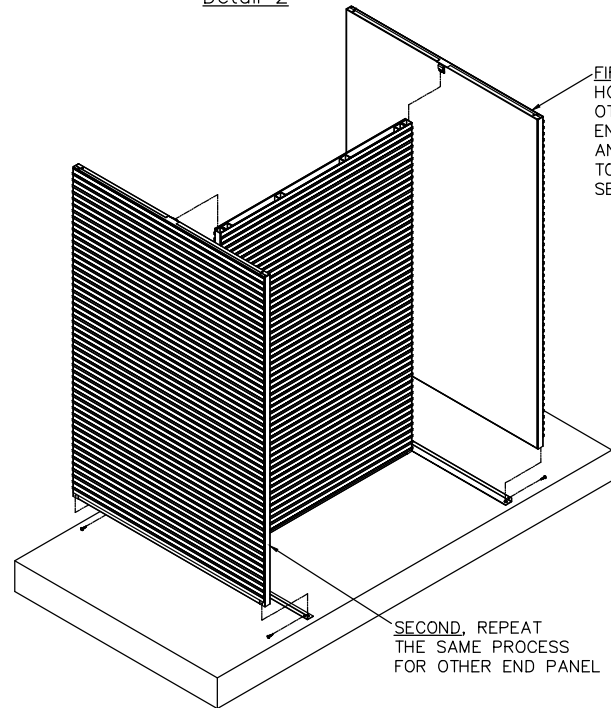

STEP-2

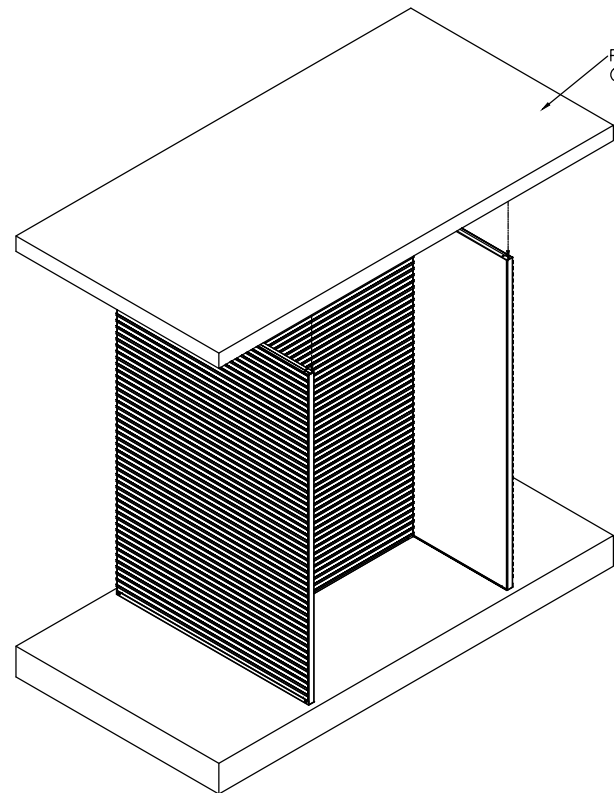

STEP-3

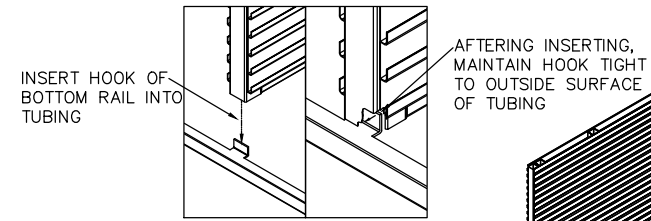

Detail 1

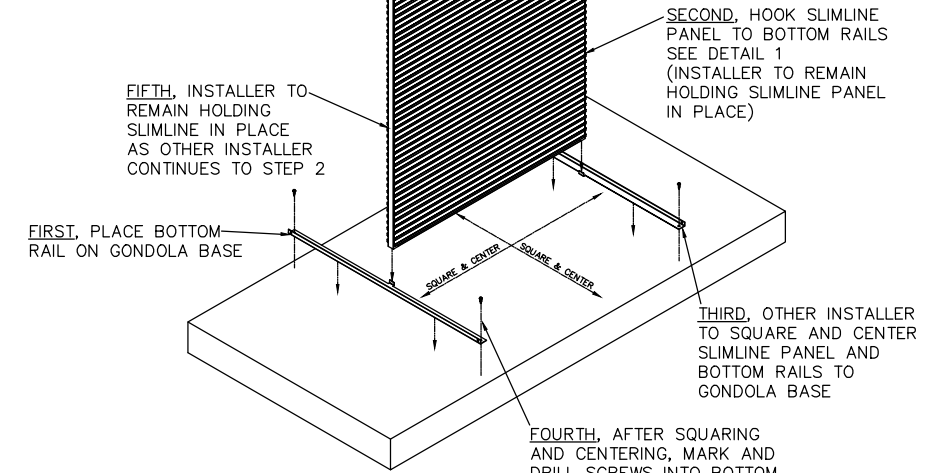

STEP-1

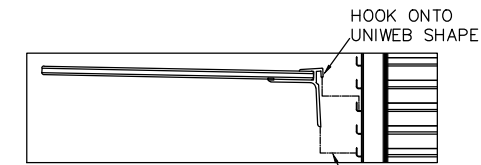

Detail 3

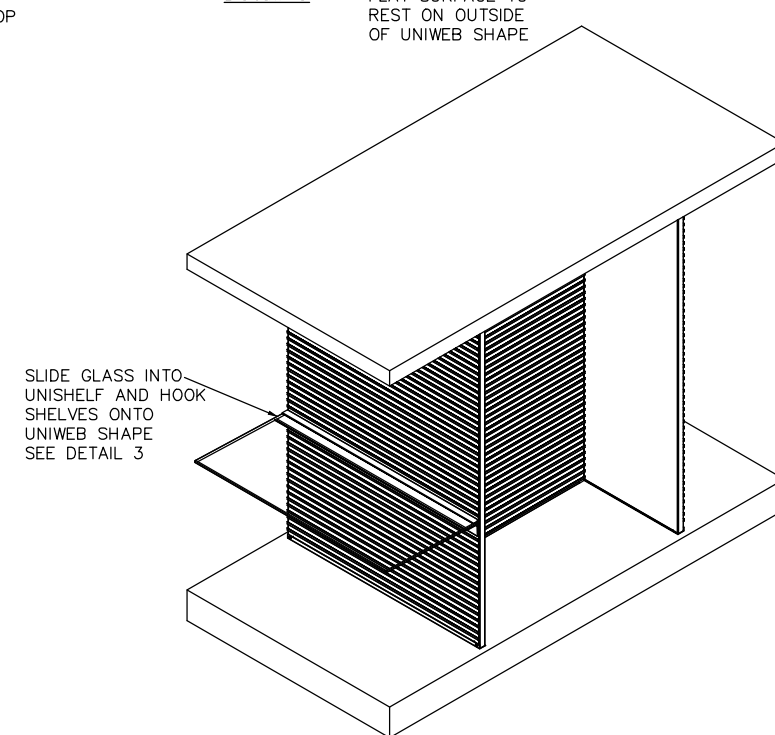

FINAL STEP

REVISIONS	DATE	BY
Δ		

This plan is primarily a general arrangement of equipment for the convenience of contractors and is made from the available information. All measurements are to be verified on the job. Where applicable plumbing, electrical, and refrigeration have been located as accurately as possible and are intended to suit equipment to be applied. We accept no responsibility for the work done by sub-contractors and will not warrant any equipment for the work done by the manufacturer or building codes, ordinances, structural conditions, or by the substitution or changes in equipment shown on this plan. This drawing is the property of Uniweb, Inc. and must be returned upon request. Any use of information contained herein or use for replication by anyone other than Uniweb, Inc. must be authorized in writing.

UNIWEB, INC.

222 S. Promenade Ave.
Corona, CA 92879
(909) 279-7999
www.uniwebinc.com

Rush Facilities
Installation Drawings
Gondola Display

DRAWN	Carlos Méndez
CHECKED	
DATE	8-2-01
SCALE	N.T.S.
FILE NO.	install-4w
SHEET	
1	1
OF	SHEETS